

morphy richards®

Smart Ideas for Your Life

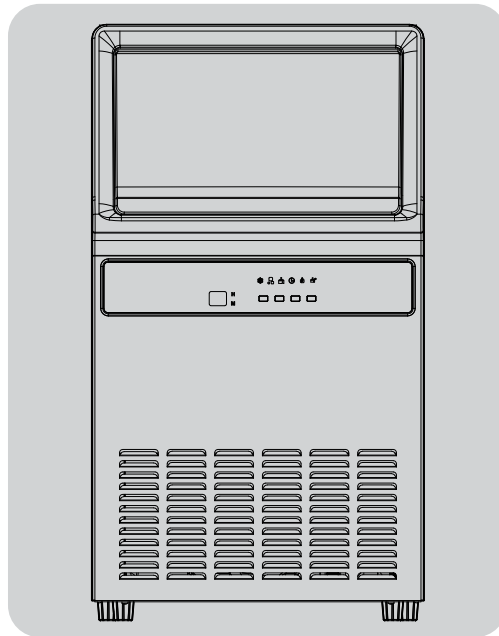

Commercial Ice Maker



Model: MRICE45BK

Read these instructions carefully before
using this appliance for the first time

For product hints and tips plus more join us at

www.morphyrichards.com.au



facebook.com/MorphyRichardsAUS



instagram.com/morphyrichardsau

IMPORTANT SAFETY INSTRUCTIONS

WARNING

To reduce the risk of fire, electric shock, injury to persons or damage to property, follow basic precautions including the following:

- **WARNING:** Misuse of appliance could cause personal injury.
- **WARNING:** Do not store explosive substances such as aerosol cans with a flammable propellant in this appliance.
- **WARNING:** Keep ventilation openings, in the appliance enclosure or in the built-in structure, clear of obstruction.
- **WARNING:** Do not use mechanical devices or other means to accelerate the defrosting process, other than those recommended by the manufacturer.
- **WARNING:** Do not damage the refrigerant circuit.
- **WARNING:** Do not pour coloured drinks or congee drinks into the machine (including the water tank and ice tray).
- **WARNING:** Do not use electrical appliances inside the food storage compartments of the appliance, unless they are of the type recommended by the manufacturer.
- **WARNING:** Do not locate multiple portable socket-outlets or portable power supplies at the rear of the appliance.
- **WARNING:** When disposing of the appliance, do so only at an authorized waste disposal centre. Do not expose to flame.
- **WARNING:** It is hazardous for anyone other than an Authorised Service Person to service this appliance. In Queensland - the authorised Service Person **MUST** hold a Gas Work Authorisation for hydrocarbon refrigerants to carry out servicing or repairs where the gas system is being opened or charged.

IMPORTANT SAFETY INSTRUCTIONS



- **DANGER:** Risk of fire or explosion. Flammable refrigerant used. To be repaired only by trained service personnel. Use only manufacturer authorized service parts. Any repair equipment used must be designed for flammable refrigerants. Follow all manufacturer repair instructions. Do not puncture refrigerant tubing.
- **WARNING:** This appliance contains a quantity of R290 refrigerant which is flammable.
- **WARNING:** Risk of fire or explosion. Dispose of refrigerator properly in accordance with the applicable federal or local regulations. Flammable refrigerant used.
- **WARNING:** Risk of fire or explosion due to puncture of refrigerant tubing; follow handling instructions carefully. Flammable refrigerant used.
- **WARNING:** Keep clear of obstructing all ventilation openings in the appliance enclosure or in the structure for building-in.
- **WARNING:** Do NOT use mechanical devices or other means to accelerate the defrosting process, other than those recommended by the manufacturer.
- **WARNING:** Do not damage the refrigerating circuit.
- **WARNING:** Do not use electrical appliances inside the ice maker.
- If the refrigerant circuit should be damaged:
- Avoid opening flames and sources of ignition.
- Thoroughly ventilate the room in which the appliance is situated.

IMPORTANT SAFETY INSTRUCTIONS

- Do not remove any safety, warning, or product information labels from the ice maker.
- Check the ice maker to ensure it is in good condition and that there is no damage to the ice maker, power cord or plug.
- This appliance is not intended for use by persons (including children) with reduced physical, sensory or mental capabilities, or lack of experience and knowledge, unless they have been given supervision or instruction concerning use of the appliance by a person responsible for their safety.
- Children should be supervised to ensure that they do not play with the appliance.
- Cleaning and user maintenance shall not be made by children without supervision.

Location

- Before using the Ice Maker for the first time, please wait 2 hours after positioning it.
- For indoor use only. Do not use outdoors or near water.
- Always locate your appliance away from the edge of the worktop.
- If the ice maker re-used after a period of time in storage, do not use for a few hours, allowing the unit to warm up to the room temperature before operating.
- Keep the appliance 15cm from other objects to ensure the heat generated is heat released.
- Never store or use gas and other flammable articles near the ice maker to avoid a fire.

IMPORTANT SAFETY INSTRUCTIONS

Power cord

- **WARNING:** When positioning the appliance, ensure the power cord is not trapped or damaged.
- The power cord should reach from the socket to the appliance without straining the connections.
- If the power cord is damaged, it must be replaced by the manufacturer, its service agent or similarly qualified persons in order to avoid a hazard.
- Remove the plug from the socket, grasp the plug and pull out the power cord, do not pull on the cord directly.
- Do not let the cord hang over the edge of a table or counter and keep it away from any hot surfaces.
- Do not let the cord run across an open space e.g. between a low socket and table.

Personal safety

- **WARNING:** To protect against fire, electric shock and personal injury do not immerse cord, plug and appliance in water or any other liquid.
- **WARNING:** The appliance surface is subject to residual heat after use.
- **WARNING:** Fill with potable water only.
- The temperature of accessible surfaces may be high when the appliance is operating.
- Unplug from the outlet before moving or cleaning to avoid damaging the refrigerating system.

IMPORTANT SAFETY INSTRUCTIONS

- Do not move the appliance while switched on.
- Do not use accessories which are not recommended by the manufacturer.
- Do not touch the evaporator when using the ice maker as the user may suffer from frostbite.
- This appliance incorporates backflow protection complying with AS/NZS 3500.1.
- No further backflow protection required for connection to the water supply.

Electrical requirements

- **WARNING:** This appliance should NOT be used with extension leads and/or power boards.
- Check that the voltage on the rating label of your appliance corresponds with the electricity supply which must be A.C.

READ CAREFULLY AND KEEP FOR FUTURE REFERENCE

SPECIFICATIONS

Model:	MRICE45BK
Colour:	Stainless Steel
Rated Power:	300W
Rated Voltage & Frequency:	220-240V~ 50Hz
Rated Current:	2.0A
Ice Bin Capacity:	13kg
Refrigerant/Amount:	R290/60g
Foaming Agent:	C₅H₁₀
Dimensions (W x D x H):	445 x 403 x 795mm
Net Weight:	25.2kg

PRODUCT OVERVIEW

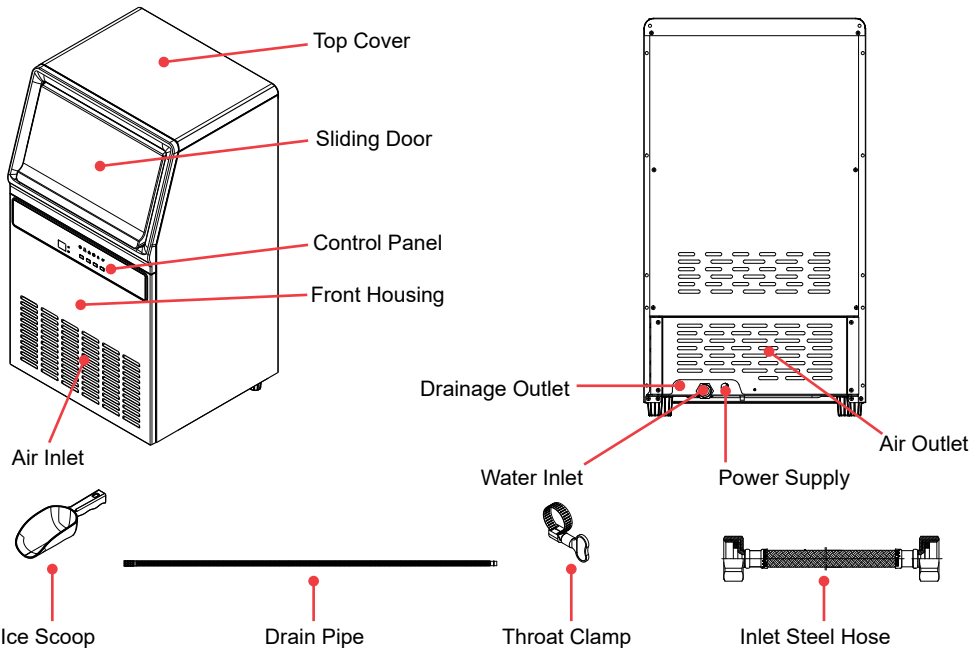

CONTROL PANEL

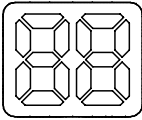

Clean

Time

Size

Button / Indicator

Function



Standby mode: when "--" is displayed:

1. Press POWER. The unit enters the ice making mode

Ice Making mode:

1. Press POWER. The unit enters into the pre-shut off mode

In pre-shut off mode: if a time is displayed, the unit will shut off after the current cycle. Press POWER to cancel this mode and the unit stops making ice at once

2. Press & hold POWER for 3 seconds. The unit starts defrosting



Clean

1. Press & hold MODE for 3 seconds. The unit starts CLEAN mode

2. Press & hold MODE for 3 seconds. The unit stops CLEAN mode



Time

Delayed Start Time function:

1. Press & hold + for 3 seconds to activate the delayed start time function
2. Adjust the time by pressing + or -
3. Press MODE confirms the selection, or wait 10 seconds and the unit confirms the selection

When the selected time is set:

1. Press & hold + for 3 seconds to be able to adjust the time
2. Press & hold + for 3 seconds to cancel this function

NOTE: The start up time ranges from 1 hour to 48 hours.

Ice size function:

1. Press & hold - for 3 seconds to activate the ice size function
2. Adjust the size by pressing + or -
3. Press MODE confirms the selection, or wait 10 seconds and the unit confirms the selection

When the selected ice size is set:

1. Press & hold - for 3 seconds to be able to adjust the ice size
2. Press & hold - for 3 seconds to cancel this function



Size

CONTROL PANEL

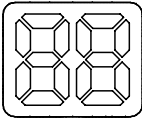

POWER

MODE

+

-

Clean

Time

Size

Button / Indicator



Function

Illuminates solidly during the ice making mode
Flashes during the pre-shutoff stage

Illuminates solidly during the ice size setting

Illuminates solidly during the cleaning mode

Illuminates solidly during the time setting

Illuminates solidly when the ice basket is full

The clean indicator will flash if the Ice Maker has been operated for 3000 cycles or the ice making time exceeds 3 month. The indicator will turn off after cleaning is performed.

Display: when "88" is displayed:

1. During the ice making mode, the time indicated will countdown
2. In standby mode, the display shows "--"
3. If the unit detects a malfunction, the code will appear in the display
4. When making ice, the size will be shown in the display:
1 = largest ice 0 = default ice size -1 = smallest ice
5. The "H" icon will illuminate under the time setting mode, this represents the hour setting
6. The "M" icon will illuminate under the ice size setting mode, and the status of the ice making countdown in minutes

BEFORE FIRST USE

1. Remove all packaging materials and read all instructions.
2. Check that all accessories are complete and the appliance is not damaged.
3. Clean all parts to remove any dust or manufacturing residue.
4. The ice maker should be placed on a level surface. Adjust the four black feet on the bottom of the unit until it is stable and even.
5. The incline angle of the ice maker should not exceed 45° during transportation or use. Do not turn the ice maker upside down. Doing so could cause the compressor or refrigerating system to operate incorrectly. Please allow time for the liquid in the compressor to settle after the ice maker is moved or transported. Before using the ice maker for the first time, please wait for 2 hours after the unit has been positioned on a level surface.
6. The appliance must be placed on a dry and level surface with sufficient ventilation, far from heat sources such as ovens, heaters and corrosive gases. Leave around 15cm clearance on all sides of the ice maker for proper ventilation.
7. Do not fill the water reservoir with cold or hot water. This may damage the ice maker. It is best to fill the water tank with water that is from a tap or room temperature. The water quality added to the tank should be drinkable.
8. It is recommended the minimum inlet water pressure is 0.04MPa and maximum inlet water pressure is 0.8MPa.
9. Do not use the appliance at a very cold environment (lower than 8°C).
10. Clean the unit by following the operation of “CARE & CLEANING” on page 12 before operating.

USING YOUR ICE MAKER

See below connection instructions before first use.

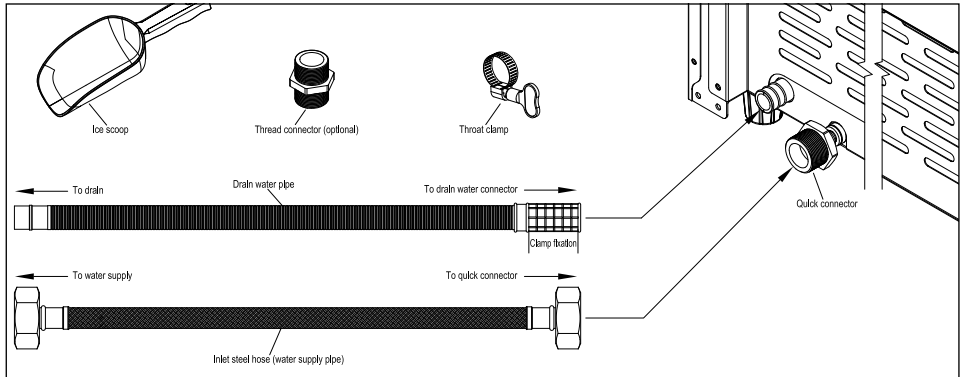

1. Connect the quick connector to the water inlet port on the rear of the unit.
2. Screw an end of the inlet steel hose to the quick connector of the unit and ensure the Blue plastic lugs are securely fastened.

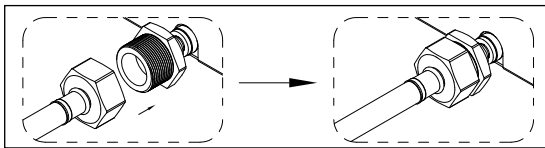

3. Screw the other end of the inlet steel hose to a 25mm water supply tap connector.

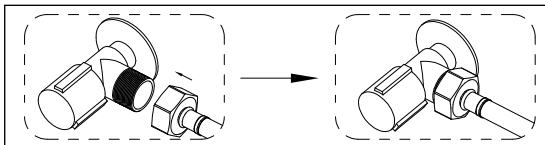

NOTE: If you wish to attach a longer inlet hose, you can purchase a 25mm thread pipe nipple joiner and 12mm wide inlet hose from a hardware shop and connect the two inlet hoses.

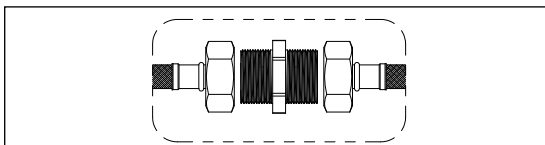

USING YOUR ICE MAKER

4. To connect the water drain pipe. Place the throat clamp on the thicker, textured end of the drain pipe. Then insert the thicker end with throat clamp of the drain pipe onto the drainage outlet on the rear of the unit. Turn the throat clamp key clockwise to tighten.

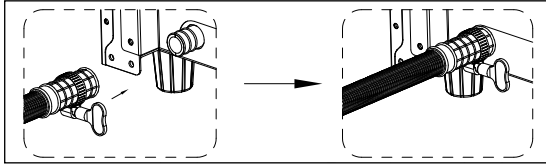

5. Put the thinner end of the drain pipe into the drain or sink.

WARNING: Due to the small working space, be careful not to hurt your hand when tightening the clamp.

6. Turn on the water supply, visually check whether there is water leakage at the connection, if there is no water leakage, connect the appropriate power supply and then turn on.

IMPORTANT: The water pressure of the main water supply system must be 0.04-0.8MPa at least.

7. Connect the unit with power source, the unit will go into Standby mode and will display "--".

NOTE: If the ice maker has been moved, allow it to rest for 30 minutes before powering on.

8. Press the POWER button to start the ice maker and water will begin to fill the machine and start the ice making process.
9. When a cycle of ice making has completed, the next cycle will begin. At this time, the NTC sensor will determine the time to make the ice, according to the ambient temperature. After a minute, the minutes remaining will show on the display. In the last minute, the seconds will countdown until the ice making cycle finishes.

USING YOUR ICE MAKER

10. The unit will continue to make ice until the ice shovel can not reset automatically, at this time, the ice basket is full and the ice full indicator illuminates solidly.
11. Remove the ice in the ice basket with the ice scoop accessory. After 15 seconds, the unit will begin to work again.
12. When ice needs to be removed, push the door until it is fully opened, and remove the ice according to your requirements with the ice scoop. This can be transferred to a freezer if needed for use later.
13. If you need to adjust the ice thickness, press & hold the - button for 3 seconds to activate the ice size function. Adjust the size by pressing + or - and press MODE to confirm the selection, or wait 10 seconds and the unit confirms the selection. See page 8 for more details.
14. To make the unit start working at a preset time automatically, press & hold the + button for 3 seconds to activate the time function. Adjust the time by pressing + or - and press MODE to confirm the selection, or wait 10 seconds and the unit confirms the selection. The ice maker can be programmed to start from 1 hour up to 48 hours. See page 8 for more details.

NOTE: Refer to page 8 for more information on the control panel.

NOTE: The length of the drain pipe is 1.5m (± 25 mm), and the inner diameter is 16mm.

CARE & CLEANING

NOTE: In order to keep the ice cubes fresh and the ice maker in good condition, please perform the following cleaning process when the clean indicator flashes.

NOTE: If the appliance is left empty for long periods, switch off, defrost, clean, dry, and leave the lid open to prevent mold developing within the appliance.

NOTE: It is recommended to use a Nickel Safe Ice Machine Cleaner in the water tank manually before cleaning with a ratio of 236ml of cleaner to 11.4L of water.

1. In the standby mode, Press & hold the POWER button to enter into the CLEAN mode, and the CLEAN indicator illuminates solidly.
2. The unit starts to be rinsed repeatedly for about 15 minutes.
3. The above cleaning process is automatic and does not require human involvement. The water pump runs for 4 minutes and then stops for 1 minute and is repeated 3 times.
4. The cleaning process is completed. The unit goes into standby mode (the cleaning process lasts for about 30 minutes).
5. Open the door and locate the drain plug and unplug manually to allow the water to drain (see below).

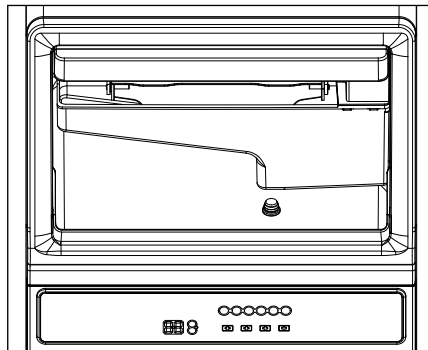

CARE & CLEANING

6. Rinse the ice basket with warm water.
7. Install the drain plug back in position, and the cleaning is completed.

NOTE: Please empty the water in the unit, wipe it with a clean cloth and store it well if the unit will not be used for a long time.

WARNING: Do not clean the ice maker with any flammable fluids. The fumes may create a fire hazard or explosion.

TROUBLESHOOTING

ERROR CODE	POSSIBLE CAUSE	SUGGESTED SOLUTIONS
E1	No water.	1. Check the water inlet valve and float. 2. Check the drain plug for any water leakage.
E2	Malfunction of the solenoid valve.	Contact the relevant Customer Care Centre.
E3	NTC malfunction.	Contact the relevant Customer Care Centre.
E5	Malfunction of the float switch.	Contact the relevant Customer Care Centre.

MAINTENANCE

If the unit fails to operate efficiently, is broken or other problems arise, unplug and do not operate.

Ask for advice by calling your local after sales service agent or the Customer Care Centre on 1300 556 816 (AU) / 0800 666 2824 (NZ).

REGISTER YOUR PRODUCT

By having your product registered on the Morphy Richards customer portal, your details can be accessed quickly in the event that there is an issue with your product. Make it quick and easy to get the help you need, if you ever need it.



WARRANTY

Please refer to the warranty letter in the box for warranty information. For any troubleshooting advice, please contact the relative Customer Care Centre below.

Glen Dimplex Australia Pty Ltd
8 Lakeview Drive,
Scoresby 3179, Victoria
Australia
Ph: 1300 556 816

Glen Dimplex New Zealand Ltd
38 Harris Road, East Tamaki,
Auckland 2013
New Zealand
Ph: 0800 666 2824

NOTES

NOTES



Recycling: Do not dispose of electrical appliances as unsorted municipal waste. Use separate collection facilities. Contact your local government for information regarding the collection systems available. If electrical appliances are disposed of in landfills or dumps, hazardous substances can leak into the ground water, polluting the food chain and damaging health and wellbeing.

Expanded Polystyrene Disposal: The websites listed below can assist in the responsible disposal of EPS (Expanded Polystyrene) packaging products.

Australia: <https://recyclingnearyou.com.au/polystyrene> and/or <http://epsa.org.au>

New Zealand: <https://greenbusinesshq.com/epsrecycling> and/or

<https://www.plastics.org.nz/environment/recycling-disposal/eps-recycling>

morphy richards

Glen Dimplex Australia Pty Ltd

8 Lakeview Drive

Scoresby VIC 3179

Phone: 1300 556 816

Email: seasonal.support@glendimplex.com.au

Web: www.morphyrichards.com.au

© Glen Dimplex Australia. All rights reserved. Material contained in this publication may not be reproduced in whole or in part, without prior permission in writing of Glen Dimplex Australia.

MRICE45BK_IM_v6