

morphy richards®

smart ideas for your home

Hand Blender Set

INSTRUCTION MANUAL

Model: MRHBS8BK

Read these instructions carefully before
using this appliance for the first time

STORE THESE INSTRUCTIONS CAREFULLY

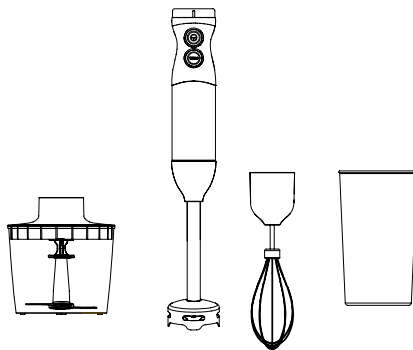

For product hints and tips plus more join us at

www.morphyrichards.com.au



facebook.com/MorphyRichardsAUS



instagram.com/morphyrichardsau

SPECIFICATIONS

Model:	MRHBS8BK
Colour:	Black
Rated Voltage:	220-240V~ 50-60Hz
Rated Power:	800W
Blender Dimensions (W x D x H):	63.5 x 63.5 x 397mm
Net Weight:	1.137kg

NAMES OF PARTS AND ACCESSORIES

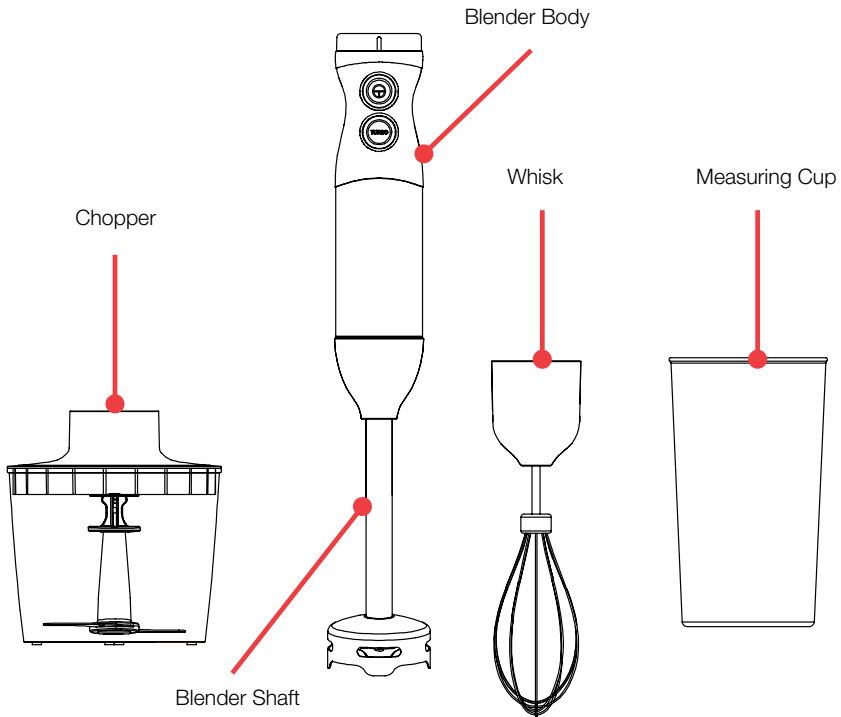

IMPORTANT SAFETY INSTRUCTIONS

WARNING

To reduce the risk of fire, electric shock, injury to persons or damage to property, follow basic precautions including the following:

- If the power cord is damaged, it must be replaced by the manufacturer or its service agent or a similarly qualified person in order to avoid a hazard.
- Keep the appliance and its cord out of reach of children.
- **WARNING:** Misuse of appliance could cause personal injury.
- This appliance is not intended to be operated by means of an external timer or a separate remote-control system.
- This appliance is not intended for use by persons with reduced physical, sensory or mental capabilities or lack of experience and knowledge unless they have been given supervision or instruction concerning use of the appliance by a person responsible for their safety.
- Children should be supervised to ensure that they do not play with this appliance.
- In the absence of supervision, the cleaning and maintenance work should not be done by a child.
- Use of accessories not recommended or sold by the original manufacturer may cause risks of fire, electric shock or personal injury.
- This appliance must be used in accordance with the instructions and must not be used for other purposes.
- This appliance is intended to be used in household and similar applications such as:

- staff kitchen areas in shops, offices and other working environments;
- farm houses;
- by clients in hotels, motels and other residential type environments;
- bed and breakfast type environments.

Location

- For indoor use only. Do not use outdoors or near water.
- The appliance and accessories should be positioned in a stable situation.

Power cord

- The power cord should reach from the socket to the blender without straining the connections.
- Remove the plug from the socket, grasp the plug and pull out the power cord, do not pull on the cord.
- Do not let the cord hang over the edge of the table or counter and keep it away from any hot surfaces.
- Do not let the cord run across an open space e.g. between a low socket and table.
- **WARNING:** This appliance should NOT be used with extension leads and/or power boards.

Personal safety

- Always disconnect the blender from the supply if it is left unattended and before assembling, disassembling or cleaning.
- **WARNING:** To protect against fire, electric shock and personal injury, do not immerse cord, plugs, or appliance in water or other liquid.
- Do not operate any appliance with a damaged lead or plug, or

after an appliance has malfunctioned, or has been dropped or damaged in any way.

- Avoid contact with moving parts. Keep hands and utensils out of containers while blending to reduce the risk of severe injury to persons or damage to the blender. A scraper may be used but must only be used when the blender is not operating.
- Do not use any of the appliance parts in a microwave or on any cooking/heated surfaces.
- Do not place on or near a hot gas or electric burner, or in a heated oven.
- To reduce the risk of injury, never place cutting blade on base without first putting the bowl properly in place.
- Ensure the chopper lid is securely locked in place before operating appliance.
- Before removing the lid from the chopper, release the button and unplug the appliance and wait until the blades have come to a complete stop.
- Always remove the blade assembly before pouring contents from measuring cup or chopper accessory.
- Be sure to switch off the blender after each use and make sure the motor stops completely before disassembling.
- **WARNING:** The blender blades and chopper blades are extremely sharp, please handle with care.
- When handling and cleaning the blade, always hold the blade stem instead of the cutting edge.
- When using the chopper accessory, always disassemble the motor unit from the chopper lid first and then remove the chopper lid. Never remove the chopper lid with the motor unit attached.

Treating scalds

- Be careful if blending hot liquid, as it can be ejected.
- Run cold water over the affected area immediately. Do not stop to remove clothing, get medical help quickly.

Electrical requirements

- Check that the voltage on the rating plate of your appliance corresponds with your house electricity supply which must be A.C.
- **WARNING:** This appliance should NOT be used with extension leads and/or power boards.

READ CAREFULLY AND KEEP FOR FUTURE REFERENCE

HAND BLENDER PARTS

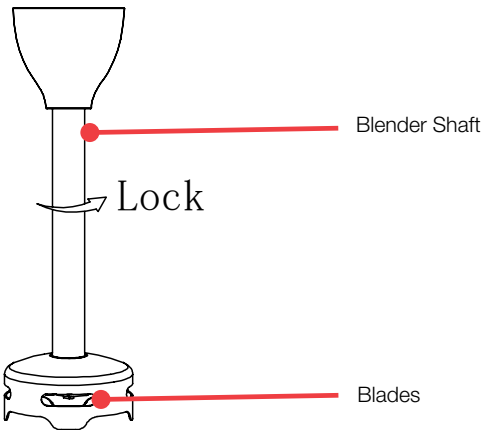
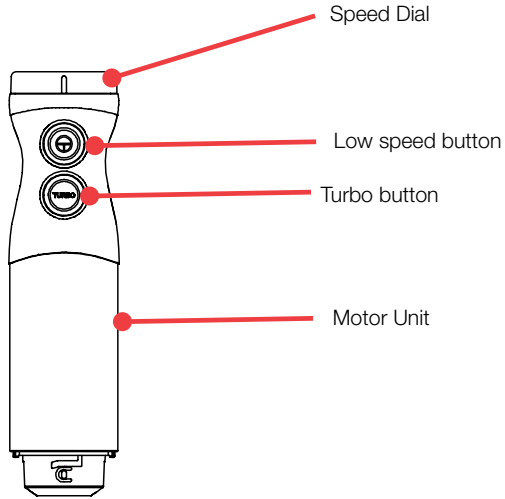

USING THE HAND BLENDER

- To avoid damage to the motor, it is recommended that the blender only operates continually for a minute and then allowed to cool for up to 3 minutes before restarting.
- To assemble the detachable shaft to the motor unit, rotate the shaft in an anti-clockwise direction until tightened. To disassemble, rotate in a clockwise direction.
- Plug the power cord into the power socket.
- Lower the blender blade assembly into the food, then press and hold the low speed button or turbo button to start operating.
- To stop the blender, simply release the low speed button or turbo button.
- Note: There is a stepless speed dial on the top of the blender. By rotating this dial clockwise increases speed, and anti-clockwise will decrease speed. The speed dial is only effective after pressing the low speed button. Once the turbo button is activated, the speed dial is ineffective.

USING THE HAND BLENDER WITH ICE

- The blender can be used for a moderate amount of ice crushing with a little water added to the ice to help keep the blade moving. Long term ice crushing without water added will cause damage to the blades and reduce the efficiency of the appliance.

USING THE CHOPPER ACCESSORY

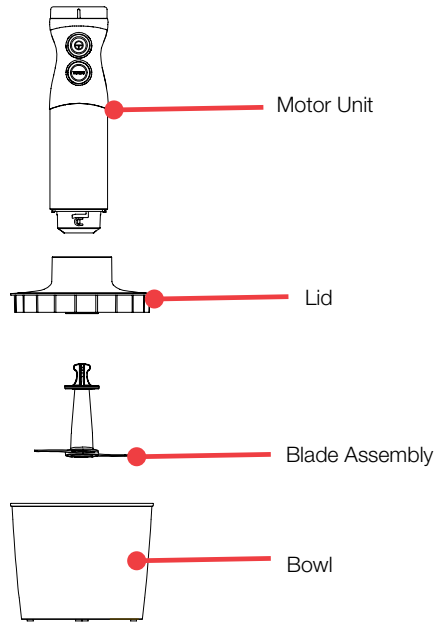

The chopper accessory is ideal for grinding meat, making pastes and chopping ingredients.

- **WARNING:** The blade assembly is extremely sharp and caution should be taken when cleaning or assembling the chopper.
- The chopper bowl should only be used for the blending of food and not storage. After use, it is recommended to clean this as soon as possible.
- Wash all accessories in warm soapy water and dry before using.
- To avoid damage to the motor, it is recommended that the blender only operates continually for a minute and then allowed to cool for up to 3 minutes before restarting.

USING THE CHOPPER ACCESSORY

- Assemble the stainless steel chopping blade into the chopper bowl, as shown below:

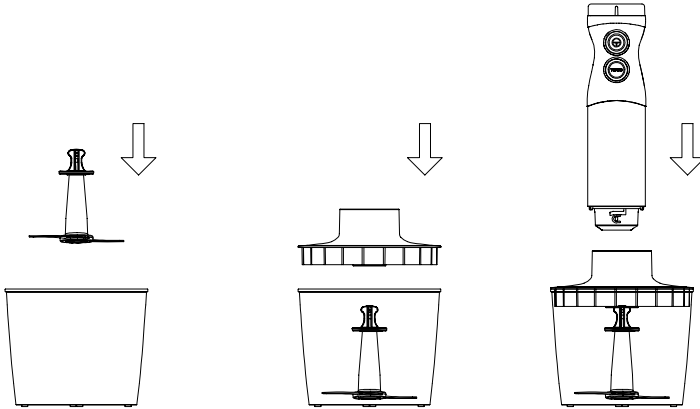

- Place food into the chopper bowl.
- Note: Food should be cut into smaller pieces before using the chopper as the capacity of the chopper bowl is 200g.
- Push the lid firmly onto the chopper bowl. To remove the lid, pull the lid up carefully to avoid spillage.
- Insert the motor unit into the hole of the chopper lid.
- Plug the power cord into the power socket.
- Press and hold the low speed button or turbo button to start operating. To stop the blender, simply release the low speed button or turbo button.
- After finishing chopping, unplug the power cord and remove the motor unit from the chopper lid. Pull the lid up to remove.

USING THE WHISK ACCESSORY

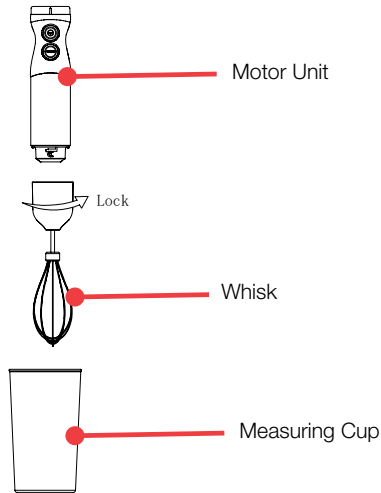

The whisk accessory is great for blending and incorporating air into ingredients such as egg whites or heavy cream.

- Wash all accessories in warm soapy water and dry before using.
- To avoid damage to the motor, it is recommended that the blender only operates continually for a minute and then allowed to cool for up to 3 minutes before restarting.
- If using the measuring cup with the whisk accessory, blend or incorporate smaller amounts, as the cup has a capacity of 700ml. The whisk can also be used with any stable bowl.
- Assemble the whisk to the motor unit by rotating the whisk anti-clockwise and remove by rotating it clockwise.
- Plug the power cord into the power socket.
- Lower the whisk into the food or liquid, then press and hold the low speed button or turbo button to start operating.
- To stop, release the low speed button or turbo button.

CLEANING

- Ensure the appliance is turned off, unplugged from the socket and remove the detachable shaft before cleaning.
- Note: Do not immerse the detachable shaft of the blender in water because over time the lubrication of the bearings may wash away.
- The steel shaft, blades and chopper blade assembly are dishwasher safe components. The bowls and whisk are not recommended for a dishwasher as the plastic components deteriorate through prolonged dishwasher use.
- Wipe the motor unit with a damp cloth. Never immerse it in water, as electric shock may occur.
- Between processing tasks, operate the blender in a cup half filled with water and turn on for a few seconds.

MAINTENANCE

If the unit fails to operate efficiently, is broken or other problems arise, unplug and do not operate.

Ask for advice by calling your local after sales service agent or the Customer Care Centre on 1300 556 816 (AU) / 0800 666 2824 (NZ).

WARRANTY

Please refer to the warranty card in the box for warranty information. For any troubleshooting advice, please contact the relative Customer Care Centre below.

Glen Dimplex Australia Pty Ltd
8 Lakeview Drive,
Scoresby 3179, Victoria
Australia
Ph: 1300 556 816

Glen Dimplex New Zealand Ltd
38 Harris Road, East Tamaki,
Auckland 2013
New Zealand
Ph: 0800 666 2824



Recycling: Do not dispose of electrical appliances as unsorted municipal waste. Use separate collection facilities. Contact your local government for information regarding the collection systems available. If electrical appliances are disposed of in landfills or dumps, hazardous substances can leak into the ground water, polluting the food chain and damaging health and wellbeing.

Expanded Polystyrene Disposal: The websites listed below can assist in the responsible disposal of EPS (Expanded Polystyrene) packaging products.

Australia: <https://recyclingnearyou.com.au/polystyrene> and/or <http://epsa.org.au>

New Zealand: <https://greenbusinesshq.com/epsrecycling> and/or

<https://www.plastics.org.nz/environment/recycling-disposal/eps-recycling>

morphy richards®

Glen Dimplex Australia Pty Ltd
8 Lakeview Drive
Scoresby VIC 3179
Phone: 1300 556 816
Email: seasonal.support@glendimplex.com.au
Web: www.morphyrichards.com.au

morphy richards®

Glen Dimplex New Zealand Ltd
1 Ron Driver Place
East Tamaki, Auckland
Phone: 09 274 8265
Email: sales@glendimplex.co.nz
Web: www.morphyrichards.co.nz

© Glen Dimplex Australia. All rights reserved. Material contained in this publication may not be reproduced in whole or in part, without prior permission in writing of Glen Dimplex Australia.