morphy richards®

illumination



Jug Kettle

Please read and keep these instructions



www.morphyrichards.com

Health and Safety

The use of any electrical appliance requires the following common sense safety rules.

Please read these instructions carefully before using the product.

- This appliance is not intended for use by persons (including children) with reduced physical, sensory or mental capabilities, or lack of experience and knowledge, unless they have been given supervision or instruction concerning use of the appliance by a person responsible for their safety.
- Children should be supervised to ensure that they do not play with the appliance.
- Cleaning and user maintenance shall not be made by children.
- Keep the appliance and its cord out of reach of children.
- If the mains cable is damaged, it must be replaced by the manufacturer, it's service agent or similarly qualified person in order to avoid a hazard.
- **WARNING: Do not open the lid whilst the water is boiling.**
- **WARNING: Misuse of appliance could cause personal injury.**
- **WARNING: Avoid spillage on the connector.**
- This appliance has an element which may be subject to residual heat after use.
- This appliance is intended to be used in household and similar applications such as: farm houses, by clients in hotels, motels and other residential type environments, and bed and breakfast type environments. It is not suitable for use in staff kitchen areas in shops, offices and other working environments.

Location

- Always locate your appliance away from the edge of the worktop.
- Ensure that the appliance is used on a firm, flat surface.
- Do not use the appliance outdoors or near water.
- **WARNING: Do not place the appliance onto a metal tray or metal surface whilst in use.**

Mains cable

- Do not let the mains cable hang over the edge of the worktop where a child could reach it.
- Do not let the mains cable run across an open space e.g. between a low socket and a table.
- Do not let the mains cable run across a cooker or other hot area which might damage the cable.
- The mains cable should reach from the socket to the base unit without straining the connections.

Personal safety

- Always keep the top of the cordless base dry, especially around the connection area, disconnect the power supply before drying. Allow to dry thoroughly before reconnection to the power supply.
- Do not fill above the MAX mark, otherwise boiling water may be ejected.
- Always pour hot water slowly and carefully without tipping the appliance too fast to prevent splashing and spillage.
- Do not hold the switch in the on position or tamper with the switch to fix it in the on position as this may cause damage to the switch-off mechanism.
- Do not move the kettle while switched on.
- CAUTION: Do not operate the kettle on an inclined plane.
- Do not operate the kettle unless the element is fully immersed.

Other safety considerations

- The use of attachments or tools not recommended or sold by Morphy Richards, may cause fire, electric shock or injury.
- The kettle is only to be used with the stand provided.
- Do not use the appliance for any use other than to boil water.
- The appliance must not be on the base unit when being filled with water.
- Unplug from the outlet when not in use.
- **WARNING: The appliance must not be immersed for cleaning.**

Electrical requirements

Check that the voltage on the rating plate of your appliance corresponds with your house electricity supply which must be A.C. (Alternating Current).

Should the fuse in the mains plug require changing, replace it with a fuse of the same rating as originally fitted.

WARNING: This appliance must be earthed.

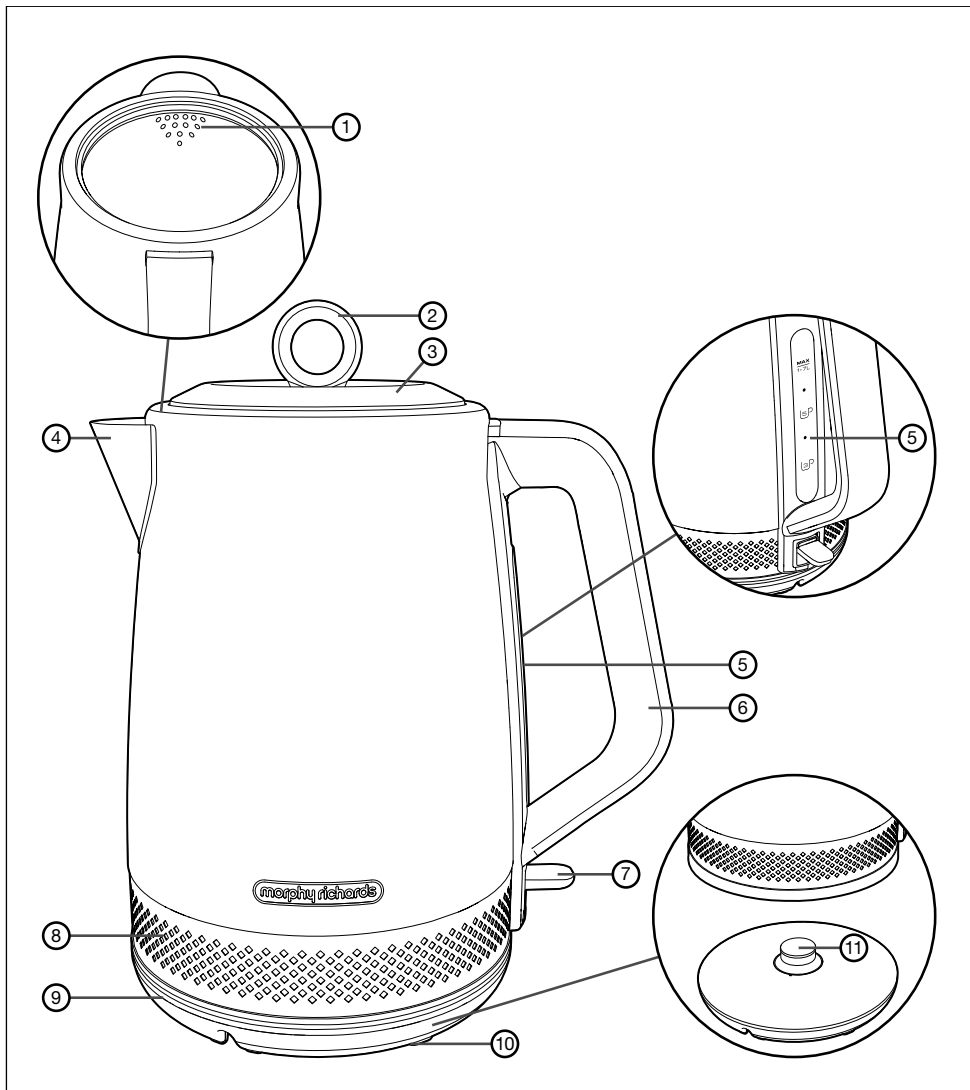

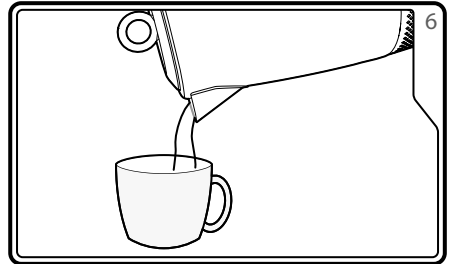
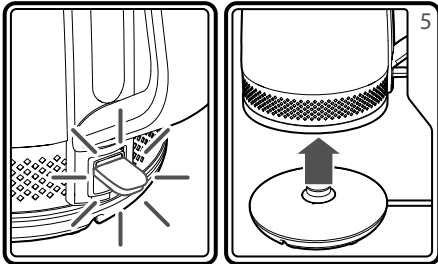
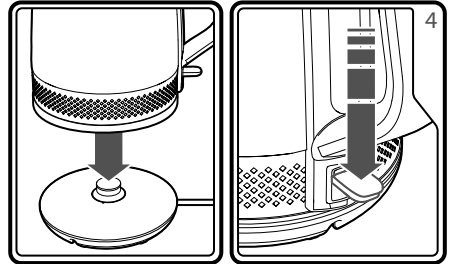
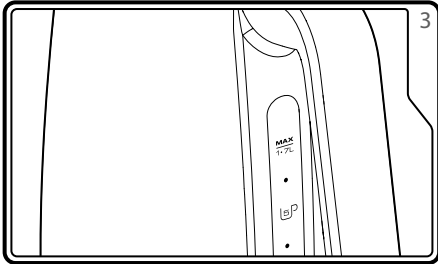
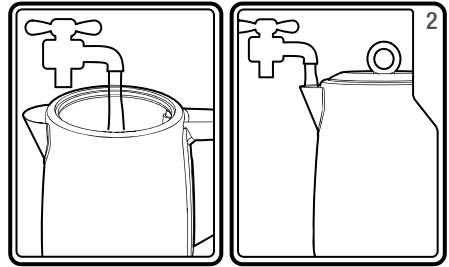
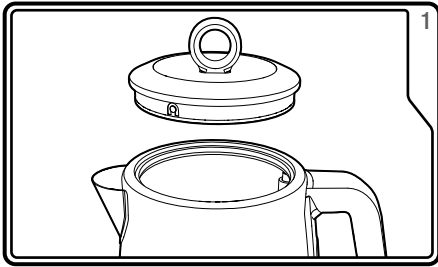

Before first use

Before using the appliance for the first time, fill with water, boil and pour away.

Features

- (1) Integrated Filter
- (2) Lid Handle
- (3) Lid
- (4) Spout
- (5) Water Gauge
- (6) Handle
- (7) On/Off Switch
- (8) Illumination Strip
- (9) Cordless Power Base
- (10) Cord Storage (underneath)
- (11) 360° Connector

Using your kettle

- 1** Lift off the Lid (3).
- 2** Fill the kettle with water, through the Lid opening, or alternatively fill through the Spout (4).
- 3** **IMPORTANT: Do not fill past the MAX line.**
- 4** Place the kettle on the Cordless Power Base (9) and press the On/Off Switch (7). The Illumination Strip (8) and On/Off Switch (7) will illuminate.
- 5** When boiled, the kettle will automatically switch off. Remove from the Cordless Power Base (9).

- 6** Pour the water from the kettle.

CAUTION: Both the kettle and water will be hot.

Cleaning your kettle

- **WARNING: Always disconnect the plug from the mains and allow the kettle to cool before cleaning.**
- Wipe the outside with a damp cloth.
- **IMPORTANT: Do not use abrasive cleaners on the outside of the kettle which may scratch the surface.**
- **Caution: To prevent damage to the appliance, do not use alkaline cleaning agents when cleaning, use a soft cloth and mild detergent.**

Descaling

IMPORTANT: As this appliance is fitted with a concealed element it must be descaled regularly. The frequency of descaling depends on usage and the hardness of the water in your area.

Excessive scale can cause the appliance to switch off before boiling and may damage the element, invalidating the warranty.

It is essential that regular descaling takes place. We recommend descaling your kettle every month.

Remove hard scale using a proprietary descaling product suitable for stainless steel, glass or plastic. Please follow the cleaning products instructions carefully.

IMPORTANT: Ensure that the electrical connections are completely dry before using the appliance.

Contact us

Helpline

If you are having a problem with your appliance, please call our Helpline, as we are more likely to be able to help than the store you purchased the item from.

Please have the product name, model number and serial number to hand when you call to help us deal with your enquiry quicker.

UK Helpline: 0344 871 0944

IRE Helpline: 1800 409 119

Spares: 0344 873 0710

Talk To Us

If you have any questions or comments, or want some great tips or recipe ideas to help you get the most out of your products, join us online:

Blog: www.morphyrichards.co.uk/blog

Facebook: www.facebook.com/morphyrichardsuk

Twitter: @loveyourmorphy

Website: www.morphyrichards.com

THIS SECTION IS ONLY APPLICABLE FOR CUSTOMERS IN UK AND IRELAND

REGISTERING YOUR TWO YEAR GUARANTEE

Your standard one year guarantee is extended for an additional 12 months when you register the product within 28 days of purchase with Morphy Richards. If you do not register the product with Morphy Richards within 28 days, your product is guaranteed for 1 year. To validate your 2 year guarantee register with us online at www.morphyrichards.co.uk

N.B. Each qualifying product needs to be registered with Morphy Richards individually. Please refer to the one year guarantee for more information.

YOUR ONE YEAR GUARANTEE

It is important to retain the retailer's receipt as proof of purchase. Staple your receipt to this back cover for future reference. Please quote the following information if the product develops a fault. These numbers can be found on the base of the product.

Model no.
Serial no.

All Morphy Richards products are individually tested before leaving the factory. In the unlikely event of any appliance proving to be faulty within 28 days of purchase, it should be returned to the place of purchase for it to be replaced. If the fault develops after 28 days and within 12 months of original purchase, you should contact the Helpline number quoting Model number and Serial number on the product, or write to Morphy Richards at the address shown. You may be asked to return a copy of proof of purchase. Subject to the exclusions set out below (see Exclusions), the faulty appliance will then be repaired or replaced and dispatched usually within 7 working days of receipt. If, for any reason, this item is replaced during the 1 year guarantee period, the guarantee on the new item will be calculated from original purchase date. Therefore it is vital to retain your original till receipt or invoice to indicate the date of initial purchase. To qualify for the 1 year guarantee, the appliance must have been used according to the instructions supplied. For example, crumb trays should have been emptied regularly.

EXCLUSIONS

Morphy Richards shall not be liable to replace or repair the goods under the terms of the guarantee where:

- 1 The fault has been caused or is attributable to accidental use, misuse, negligent use or used contrary to the manufacturer's recommendations or where the fault has been caused by power surges or damage caused in transit.
- 2 The appliance has been used on a voltage supply other than that stamped on the products.
- 3 Repairs have been attempted by persons other than our service staff (or authorised dealer).
- 4 The appliance has been used for hire purposes or non domestic use.
- 5 The appliance is second hand.
- 6 Morphy Richards are not liable to carry out any type of servicing work, under the guarantee.
- 7 Plastic filters for all Morphy Richards kettles and coffee makers are not covered by the guarantee.
- 8 Batteries and damage from leakage are not covered by the guarantee.
- 9 The filters have not be cleaned and replaced as instructed.

This guarantee does not confer any rights other than those expressly set out above and does not cover any claims for consequential loss or damage. This guarantee is offered as an additional benefit and does not affect your statutory rights as a consumer.

YOUR INTERNATIONAL TWO YEAR GUARANTEE

This appliance is covered by two-year repair or replacement warranty.

It is important to retain the retailers receipt as proof of purchase. Staple your receipt to this back cover for future reference.

Please quote the following information if the product develops a fault. These numbers can be found on the base of the product.

Model no.
Serial no.

All Morphy Richards products are individually tested before leaving the factory. In the unlikely event of any appliance proving to be faulty within 28 days of purchase it should be returned to the place of purchase for it to be replaced.

If the fault develops after 28 days and within 24 months of original purchase, you should contact your local distributor quoting Model number and Serial number on the product, or write to your local distributor at the addresses shown.

You will be asked to return the product (in secure, adequate packaging) to the address below along with a copy of proof of purchase.

Subject to the exclusions set out below (1-9) the faulty appliance will then be repaired or replaced and dispatched usually within 7 working days of receipt.

If for any reason this item is replaced during the 2-year

AUS

guarantee period, the guarantee on the new item will be calculated from original purchase date. Therefore it is vital to retain your original till receipt or invoice to indicate the date of initial purchase.

To qualify for the 2-year guarantee the appliance must have been used according to the manufacturers instructions. For example, appliances must have been descaled and filters must have been kept clean as instructed.

The local distributor shall not be liable to replace or repair the goods under the terms of the guarantee where:

- 1 The fault has been caused or is attributable to accidental use, misuse, negligent use or used contrary to the manufacturers recommendations or where the fault has been caused by power surges or damage caused in transit.
- 2 The appliance has been used on a voltage supply other than that stamped on the products.
- 3 Repairs have been attempted by persons other than our service staff (or authorised dealer).
- 4 Where the appliance has been used for hire purposes or non domestic use.
- 5 The appliance is second hand.
- 6 The local distributor are not liable to carry out any type of servicing work, under the guarantee.
- 7 The guarantee excludes consumables such as bags, filters and glass carafes.
- 8 Batteries and damage from leakage are not covered by the guarantee.
- 9 The filters have not been cleaned and replaced as instructed.

This guarantee does not confer any rights other than those expressly set out above and does not cover any claims for consequential loss or damage. This guarantee is offered as an additional benefit and does not affect your statutory rights as a consumer.

AUSTRALIAN WARRANTY

This appliance is guaranteed for 2 years against faulty material, components and workmanship.

This warranty is in addition and does not affect your statutory rights.

Proof of purchase must be produced for any warranty benefit.

In the unlikely event of any appliance proving to be faulty, securely pack and return the item to the place of purchase accompanied by the original receipt or invoice.

Our goods come with guarantees that cannot be excluded under the Australian Consumer Law. You are entitled to a replacement or refund for a major failure and for compensation for any other reasonably foreseeable loss or damage. You are also entitled to have the goods repaired or replaced if the goods fail to be of acceptable quality and the failure does not amount to a major failure.

NOT COVERED BY THIS WARRANTY

(Australian only)

- If the appliance has not been used in accordance with the manufacturers' recommendations or Instructions.
- If the fault is deemed to be caused by abuse, misuse, neglect, modifications or in proper use and or care
Eg: Kettles: Excessive build up of scale.
Toasters: Excessive build up of crumbs or foreign matter etc.
- Connection to incorrect voltage to that stamped on the product.
- Unauthorised repairs.
- Appliance used other than for domestic purposes.
- Excluding bags, filters, glass, carafes, and cutting blades.
- Freight and insurance costs.

If for any reason this item is replaced during the 2 year guarantee period, the guarantee on the new item will be calculated from original purchase date. Therefore it is vital to retain your original receipt or invoice to indicate the date of original purchase.

Morphy Richards's policy is to continually improve quality design and product quality. The company therefore reserves the right to change any specifications or to carry out modifications as deemed worthy at any time.

The Australian supplier reserves the right to repair, modify, exchange or replace the faulty appliance with the same or similar model or product of equivalent value.

AU Glen Dimplex Australia

8 Lakeview Drive, Scoresby, Victoria 3179
T : 1300 556 816
E : sales@glendimplex.com.au

NZ Glen Dimplex Australasia

38 Harris Road, East Tamaki, Auckland 2013, New Zealand
T: 0800 666 2824
E : sales@glendimplex.co.nz

morphy richards[®]

KT108020MAUS Rev 1 07/20

www.morphyrichards.com